



EDELBROCK PERFORMER SERIES CARBURETORS

Catalog #1403, 1404, 1405, 1406, 1407, 1409, 1410, 1411, 1412, & 1413

INSTALLATION INSTRUCTIONS

PLEASE study these instructions carefully before beginning this installation. Most installations can be accomplished with common tools and procedures. However, you should be familiar with and comfortable working on your vehicle. If you do not feel comfortable performing this installation, it is recommended to have the installation completed by a qualified mechanic. If you have any questions, please call our **Technical Hotline at: 1-800-416-8628**, 7:00 am - 5:00 pm, Pacific Standard Time, Monday through Friday or e-mail us at edelbrock@edelbrock.com.

IMPORTANT NOTE: Proper installation is the responsibility of the installer. Improper installation may result in poor performance and engine or vehicle damage.

PLEASE complete and mail your warranty card. Be sure to write the model number of this product in the "Part #____" space. **THANK YOU.**

DESCRIPTION: Edelbrock Performer Series carburetors have been calibrated, factory flow-tested, and preset. These instructions also apply to carburetors featuring our EnduraShine™ finish. Please read all instructions prior to installation. For "Theory of Operation" and "Tuning Procedures", see the accompanying carburetor Owner's Manual. **These are non-emissions carburetors, check your local emissions laws.**

NOTE: Edelbrock Performer Series carburetors are not for computer-controlled applications. That includes some 1981 & later GM vehicles with Q-Jet carburetor and some 1981 & later Ford vehicles with automatic overdrive (AOD) transmissions.

KIT CONTENTS:

- | | |
|--|--|
| <input type="checkbox"/> 1 Installation instruction sheet | <input type="checkbox"/> 2 5/32" Vacuum caps (Except #1409 & 1410) |
| <input type="checkbox"/> 1 Owner's Manual | <input type="checkbox"/> 1 5/32" Vacuum "T" (Except #1409 & 1410) |
| <input type="checkbox"/> 1 Warranty card | <input type="checkbox"/> 1 1/4" NPT pipe plug (Except #1409 & 1410) |
| <input type="checkbox"/> 1 Square-bore base gasket | <input type="checkbox"/> 1 Throttle cable ball end stud - 10-32 x .250"
(Except #1409 & 1410) |
| <input type="checkbox"/> 1 Air horn gasket | <input type="checkbox"/> 1 10-32 Hex nut (Except #1409 & 1410) |
| <input type="checkbox"/> 1 Air cleaner stud | <input type="checkbox"/> 1 3/16" Internal star washer (Except #1409 & 1410) |
| <input type="checkbox"/> 1 Red choke positive wire (Electric choke carburetors only) | <input type="checkbox"/> 4 5/16" SAE flat washers (EnduraShine™ finish only) |
| <input type="checkbox"/> 1 Black choke ground wire (Electric choke carburetors only) | |

CHECK THE FOLLOWING BEFORE BEGINNING INSTALLATION

WARNING: WHEN WORKING AROUND GASOLINE, ALWAYS WORK IN A WELL VENTILATED AREA, AND KEEP ALL OPEN FLAMES, SPARKS AND OTHER SOURCES OF IGNITION AWAY FROM THE WORK AREA. FAILURE TO DO SO CAN RESULT IN A FIRE OR EXPLOSION.

- | | |
|---|---|
| <input type="checkbox"/> Replace fuel filter. Dirt found in carburetor voids warranty. | <input type="checkbox"/> Check the intake manifold and cylinder head gaskets for leaks and replace if necessary. |
| <input type="checkbox"/> Check and replace the air filter if necessary. | <input type="checkbox"/> Check the ignition system: clean and gap or replace spark plugs, plug wires, and adjust ignition timing. |
| <input type="checkbox"/> Check PCV valve and replace if clogged. | |
| <input type="checkbox"/> Check all hoses for leaks or cracks and replace if necessary. | |
| <input type="checkbox"/> Check fuel pump for proper operation and replace if necessary. | |

PARTS RECOMMENDED FOR INSTALLATION

- | | |
|--|---|
| <input type="checkbox"/> New fuel filter (Edelbrock #8135 or equivalent). | Edelbrock carbs on intake manifolds designed for 4-bbl. carburetors only! |
| <input type="checkbox"/> Chrome Steel Fuel Line Kit #8134 includes fuel filter. | <input type="checkbox"/> Throttle Linkage Kits for Ford or Chrysler applications
(See Carburetor PREPARATION, Step #1). |
| <input type="checkbox"/> Banjo Fuel Fitting #8089 (if required for fuel line clearance using your air cleaner). | <input type="checkbox"/> Throttle, trans. and cruise control bracket #8031, #8036 or #8030 (chrome) for 1972-78 small-block Chevrolet. Other applications may require modification to original bracket. |
| <input type="checkbox"/> New air cleaner (Edelbrock #1221 or #4221 is recommended). If stock or other air cleaner is to be used, check fit on carburetor before installation to determine if Edelbrock air cleaner spacer #8092 is required. | <input type="checkbox"/> Universal throttle return spring kit #8005 (If original return spring can not be used) |
| <input type="checkbox"/> Choke cable kit (manual choke only) or electrical connectors (electric choke only). | <input type="checkbox"/> Divided square-bore heat insulator gasket #9266 for dual-plane (stock or Performer-type) manifolds. May be used in place of square-bore adapter plate #2732 on some Edelbrock manifolds. |
| <input type="checkbox"/> Carburetor adapter, if carburetor is to be installed on other than square-bore intake manifold. See Steps #4 and #5 following for specific part numbers. Do not use a 4-bbl. to 2-bbl. adapter (Use | |

RECOMMENDED TOOLS

- | | |
|---|---|
| <input type="checkbox"/> Sockets/wrenches/tubing wrenches | <input type="checkbox"/> Torx Driver (for electric choke models) |
| <input type="checkbox"/> Pliers | <input type="checkbox"/> Wire crimpers (for electric choke models) |
| <input type="checkbox"/> Screwdrivers | <input type="checkbox"/> Test Meter or Test Light (for electric choke models) |
| <input type="checkbox"/> Hacksaw and/or tubing cutter | |

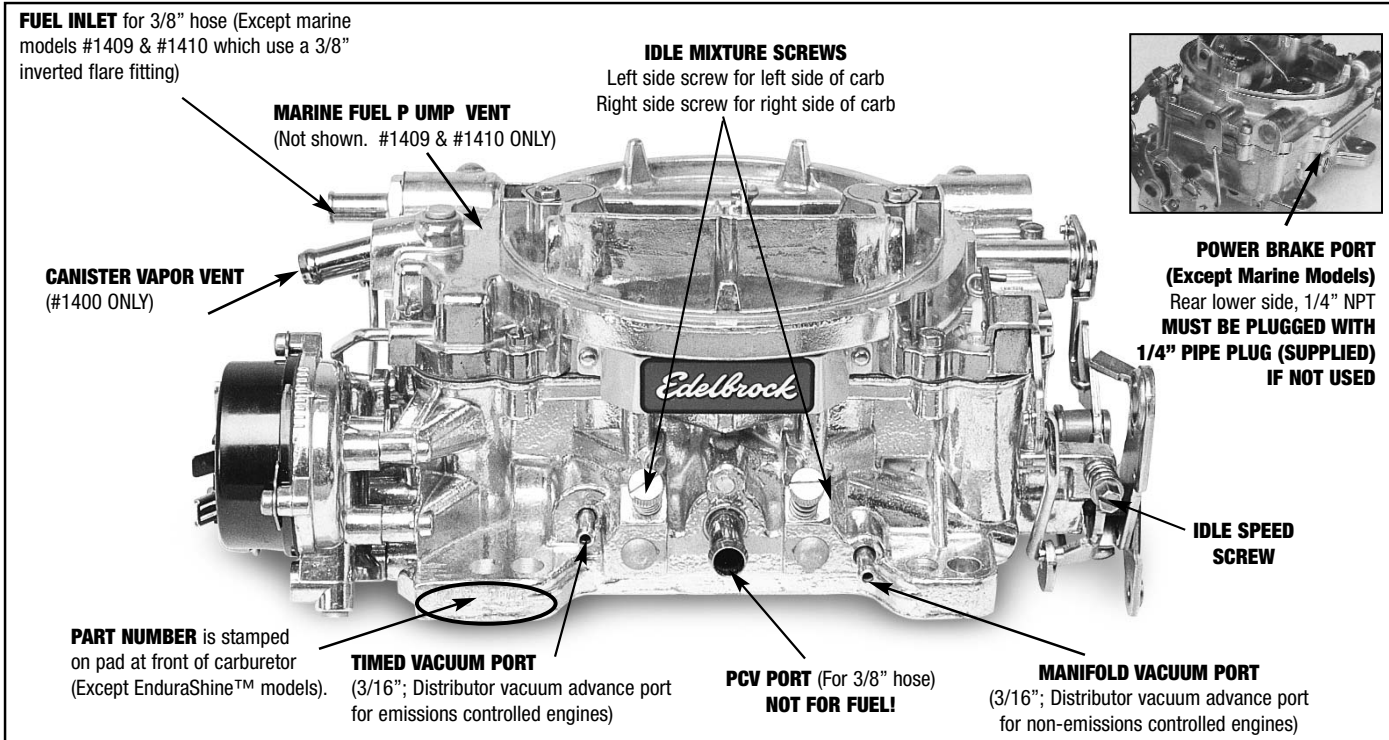

Figure 1 - Fittings and Vacuum Port Locations

INSTALLATION PROCEDURE

BEFORE REMOVING OLD CARBURETOR

1. **Determine if the distributor vacuum port is timed (no vacuum at idle) or full (vacuum present at idle).** With the engine fully warmed up and idling, pull the vacuum hose off of the carb and "feel" for vacuum by putting your finger on the vacuum port (**See Fig. 2**). If your distributor has timed vacuum advance, hook the vacuum hose from the distributor up to the passenger side vacuum port on the carburetor. If it has full vacuum advance, hook it up to the driver's side port.

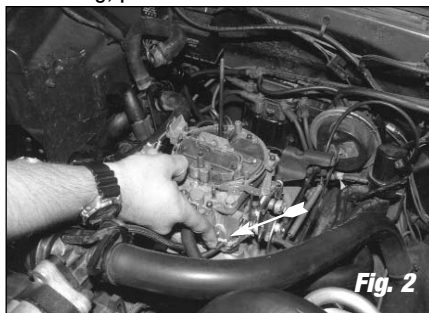

Fig. 2

2. **The stock steel fuel line must be converted to fuel resistant rubber hose.** The stock steel line will not connect to the Performer Series Carburetor. Use Edelbrock Universal Fuel Line Kit #8135. This kit contains a filter, neoprene hose and fittings to adapt 5/16" and 3/8" stock fuel lines (**See Fig. 3**).

NOTE:
After cutting fuel line remove sharp edges and clean out any chips.

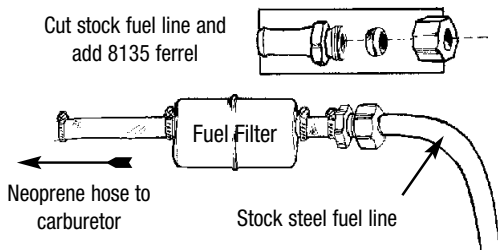

Figure 3 - Fuel Line Kit #8135 installed on stock steel fuel line

3. **Always use a new fuel filter.** Failure to do so will void the warranty.
4. **You must use an Edelbrock Adapter #2696 or Adapter/Fuel Line Kit #2697** when installing a Performer Series Carburetor on a General Motors Quadrajet or Chrysler Thermoquad manifold. #2697 includes adapter #2696 and fuel line kit #8135. **Do not use an open adapter! (See Fig. 4)**



Fig. 4

5. You must use an Edelbrock Adapter #2732 when installing a Performer Series Carb on certain Edelbrock intake manifolds. In those applications, install the adapter as shown (**See Fig. 5**).

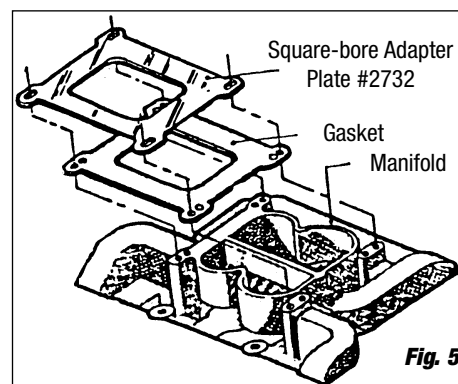

Fig. 5

6. **Do not use more than 6.5 psi fuel pressure.** Excessive fuel pressure may cause flooding. If your fuel pressure is too high, install an adjustable pressure regulator such as Edelbrock #8190.
7. It may be necessary to re-route the fuel line to prevent interference with the air cleaner. Test fit your air cleaner on your new carburetor before you begin installation. Look for areas of interference such as the choke housing, fuel inlet fitting and fuel line.

PERFORMER SERIES CARBURETOR INSPECTION

1. Check for possible damage to carburetor.
2. Make sure all throttle linkages operate freely.
3. Ensure that all fuel inlet and vacuum ports are free from packing material.

CARBURETOR REMOVAL

1. Prior to removal make sure that the engine is cool.
2. Disconnect negative battery cable from battery.
3. Remove air cleaner. Be sure to carefully disconnect any hoses from the air cleaner and note their location for re-installation. You may want to mark them with masking tape for easy reference.
4. Disconnect throttle linkage, kickdown linkage (certain automatic transmission applications only), cruise control (if equipped) and any return springs if present.

NOTE: Check carefully for the precise location of all these linkages and return springs. You may want to mark them with masking tape for easy reference.

5. Disconnect all wires, tubes and hoses from carburetor and note their location.

NOTE: There should be a maximum of one wire to the electric choke and one to the idle compensator solenoid. Any other electrical wiring attached to your carburetor indicates a computer controlled engine, and Edelbrock carburetor will not function correctly on computer controlled applications.

6. Disconnect the heater tube from the choke housing (if so equipped). Edelbrock carburetors do not use the hot air style choke, so this tube may be left disconnected with no problems. If you want to cover this opening on a stock intake manifold, you may be able to use the appropriate Edelbrock choke adapter plate: #8901 for small-block Chevrolets; #8961 for big-block Chevrolets; #8951 for Oldsmobile V8s; #8971 for 351-M/400 Fords; #8981 for 351-W Fords.
7. Carefully remove fuel line from carburetor. **TAKE EXTREME CARE NOT TO SPILL ANY EXCESS FUEL.** Place a rag underneath the fuel line to absorb any spillage that may occur. Certain models require two wrenches to remove the fuel line; one to hold the fitting on the carburetor and the second to turn the fitting on the fuel line. Use a tubing wrench to avoid rounding the tube fitting nut.
8. Remove mounting nuts or bolts and washers. Be sure to put them where they won't fall into the intake manifold upon carburetor removal.
9. Remove carburetor, being careful not to spill any dirt into the intake manifold. Immediately place a clean rag into the manifold to keep foreign objects out.
10. Remove old mounting gasket and thoroughly clean mounting surface. Compare old carb gasket to gasket included with new carburetor. If there is a difference in bolt pattern or bore spacing, an adapter will be required (see "Before Removing Old Carburetor", steps #4 & #5).

CARBURETOR PREPARATION

1. Compare throttle arm of your new carburetor with the old one to be sure that all required linkages will hook up. Install proper throttle and transmission linkage for your particular application. Throttle stud is removable and must be installed in the proper location.

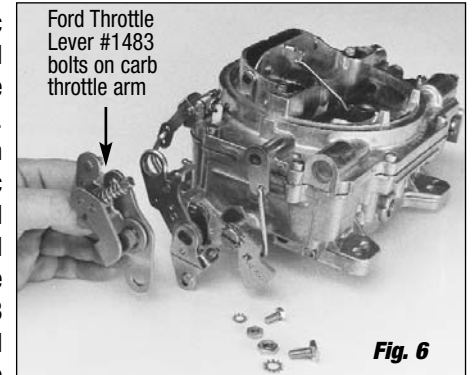

Fig. 6

Chrysler vehicles with automatic transmission will require Throttle Lever Kit #1481. Ford vehicles with a u t o m a t i c transmission and cable linkage will require Throttle Lever Kit #1483 (**See Fig. 6**) and Throttle Cable Plate Kit #1490 (for 289-302), #1491 (for 351-W), #1493 (for 351-C & 351-M/400), or #1495 (for 429/460).

2. Check and prepare carburetor for proper vacuum fitting installation (EGR, power brakes, PCV, distributor, transmission, etc.) using supplied vacuum caps, "T", and hose when applicable. **If vacuum port at rear of carb is not used, plug with the 1/4" pipe plug supplied (Except marine models, port is not drilled).**

3. On electric choke models (**See Fig. 7**), remove one choke housing retaining screw and install eyelet end of choke ground wire (black) to choke housing and reinstall screw. Connect clip end of choke ground wire to negative (-) spade terminal on choke housing.

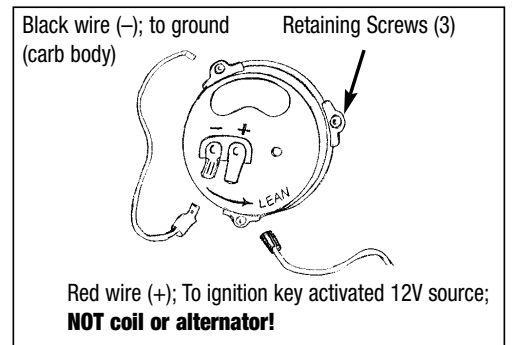

Figure 7- Choke Wire Installation

CARBURETOR INSTALLATION

1. Remove rag from intake manifold and install new studs, mounting gasket and adapters (where applicable).
NOTE: Do not use any cement, glue or RTV sealant on gasket.
2. Carefully place new carburetor on gasket.
3. Replace all mounting nuts and washers. EnduraShine™ finish carburetors should use the supplied 5/16" flat washers under any other washers used. Hand tighten with a short box end wrench, alternating between diagonally opposed nuts.

CAUTION: Overtightening may break carb base and void warranty.

- Connect all throttle and transmission linkages and throttle return springs. You may have to cut, bend or modify your stock throttle cable brackets to fit the new carburetor, or use GM #352279 (**See Fig. 8**). 1972-78 small-block Chevys may use Edelbrock Throttle, Transmission, and Cruise Control bracket #8031 #8036 or #8030 (chrome).

IMPORTANT NOTE: With engine off make sure that there is no interference when opening and closing the throttle. Be sure there is no binding or hanging up between idle and wide open throttle as this could cause the throttle to stick open, resulting in loss of engine speed control.

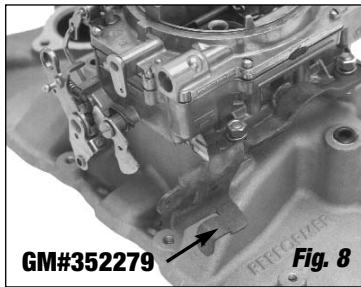

Fig. 8

- Connect manual choke cable to the provided lever attachment point and cable mounting bracket (**See Fig. 9**) (manual choke models).

Electric choke models connect red choke wire to 12 volt + source that is activated by ignition switch (**Not coil or alternator, see Figure 7**).

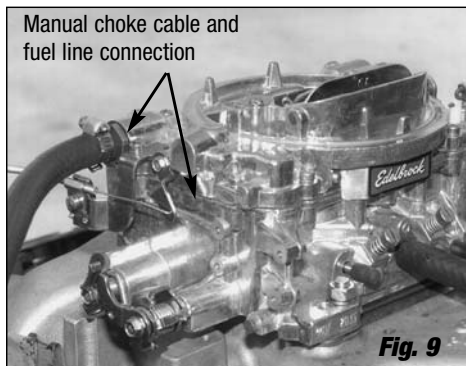

Fig. 9

NOTE: If manual choke is not connected (secondary carb of dual carb set-up, for example) then choke blade must be fixed open. To lock open, use a stiff piece of wire between the choke lever and the mounting bracket. Fold the wire to double it's thickness about one inch from one end. Insert the wire in the choke lever, hold choke blade in the wide open position, and tighten cable clamp on folded end of wire.

- Connect all vacuum hoses to their proper location on carburetor (**See Figure 1**). Replace hoses that appear brittle or cracked to prevent vacuum leaks.

- Connect fuel line to carburetor. Avoid contact with any sharp edges or areas of extreme heat.

NOTE: Some late model Ford 460 engines are equipped with hot fuel bypass units. It is necessary to replace the stock unit with Ford #E3T29N176B (with blue dot) which has a 0.040" orifice.

- Edelbrock idle compensator #8059 may be installed to raise idle speed during air conditioning compressor operation.

- Install new air horn gasket and air cleaner stud (supplied). Install air cleaner making sure it does not contact linkage or fuel line and has proper hood clearance. We recommend Edelbrock Pro-Flo chrome air cleaner #1221, which is a 14" diameter open element air cleaner that is designed to fit all Edelbrock Performer Series carburetor. Extremely low profile air cleaners will not fit electric

choke carburetor without air cleaner spacer #8092 (due to choke and fuel line interference) but will fit manual choke carburetor when used with 90° banjo fuel inlet fitting #8089 (**See Fig. 10**).

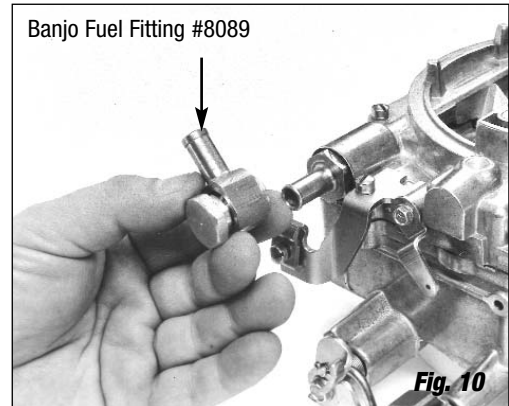

Fig. 10

- Mark air cleaner stud for proper length, remove from carburetor and cut with hack saw. Deburr stud and re-install in carburetor, along with the air cleaner (**See Fig. 11**).



Fig. 11

- Re-check all linkage for smooth throttle operation.
- Re-connect the negative battery cable to the battery.
- Start the engine and check for fuel or vacuum leaks. With engine at normal operating temperature and choke fully open, set idle speed and mixture screws (see carburetor Owner's Manual).

CAUTION: Be alert to carburetor flooding. Flooding can be caused by dirt, small particles of hose cuttings, floats and inlet needles which have settled during shipping. When the fuel pump is turned on or when the engine is first started, watch closely for signs of flooding. If flooding occurs turn engine off immediately and lightly tap on the side of the carburetor that is flooding, in the rear needle and seat area with a rawhide mallet or wooden handle of a hammer. Start engine and see if flooding continues, if so refer to owners manual.

WARNING: NEVER POUR FUEL DIRECTLY DOWN THE CARBURETOR WHEN ATTEMPTING TO START THE ENGINE! THIS MAY CAUSE A BACKFIRE AND POSSIBLE ENGINE COMPARTMENT FIRE, RESULTING IN ENGINE OR VEHICLE DAMAGE, PERSONAL INJURY AND/OR DEATH.

**Edelbrock Corporation • 2700 California St. • Torrance, CA 90503
Tech-Line: 800-416-8628 • E-Mail: Edelbrock@Edelbrock.com**