



INSTALLATION INSTRUCTIONS FOR 20-48-1 & 20-49-1 THROTTLE SHAFT KITS P/N 199R9735

WARNING! TO PRESERVE THE WARRANTY, THESE INSTRUCTIONS MUST BE READ AND FOLLOWED THOROUGHLY AND COMPLETELY BEFORE AND DURING THE INSTALLATION!

GENERAL: These are basic general instructions to remove and install the throttle shaft in any two or four barrel Holley carburetor. Since a four barrel carburetor was used in this instruction sheet, the same basic removal and installation steps apply to two barrels also.

IMPORTANT NOTE: Before starting the actual work, go through a "dry" run with the throttle body and the instruction sheet. This will help you familiarize yourself and gain confidence with all the procedures.

TOOLS NEEDED:

Phillips screwdriver	Standard screwdriver
Vise	Wood Blocks
Duct tape	Fine/Medium file
WD-40	Loctite Grade 290
"Duck Billed" tip vise grips	Access to compressed air
Carburetor stand (or suitable holding fixture)	

REMOVAL:

1. As shown in Figure 1, place the carburetor on its side to remove the throttle body screws. On vacuum secondary four barrels, it will be necessary to remove the "C" clip that holds the vacuum diaphragm stem onto the secondary throttle shaft. Also, remove the secondary throttle connecting rod. Place all screws, clips, and links on the side for later installation.
2. In Figure 2, the throttle body has been removed from the main body and placed on a carburetor stand.

RECOMMENDATION: When servicing a carburetor off the vehicle, it is recommended to place it in a suitable holding fixture. This helps prevent damage to the machined surfaces of the throttle body.



Figure 1

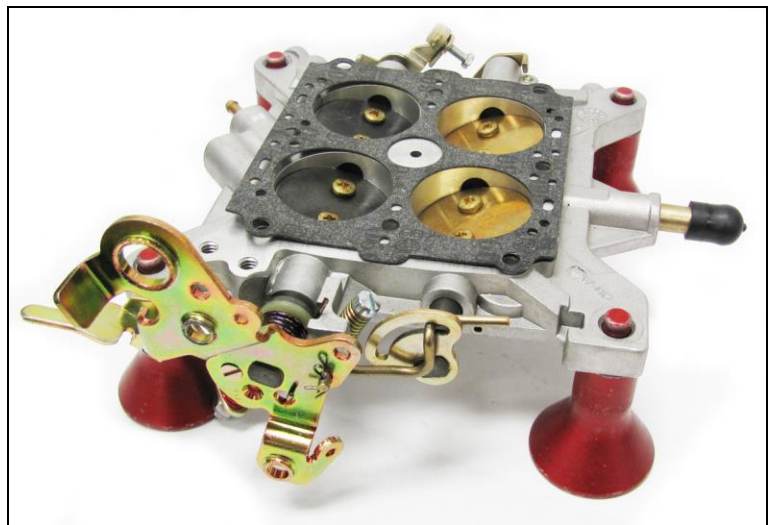

Figure 2

3. Open the primary throttle shaft to the wide-open position. To help keep the throttle open, use a wedged shape piece of soft wood positioned between the throttle shaft and the rear of the primary throttle bore. Next, cut a piece of duct tape large enough to extend at least 1 inch through the top and bottom of the front side of the primary throttle bore. Two pieces of tape in each bore may be used to accomplish this also.
4. Figure 3 shows how the duct tape is in place on the front side of the primary bore. Using duct tape (or similar heavy tape) will eliminate any damage to the bore during the filing operation.
5. Take the throttle body and place it between two blocks of wood in a vise.
6. Using a fine/medium tooth file, begin by filing the end of the throttle plate screw using firm and even strokes (Figure 4). File away enough of each screw, so that the ends are flush with the throttle shaft. When all four screws have been filed down flush with the shaft, remove the throttle body from the vise, take out the wood wedges from the bores and remove the throttle plate screws. **DO NOT** remove the duct tape yet.

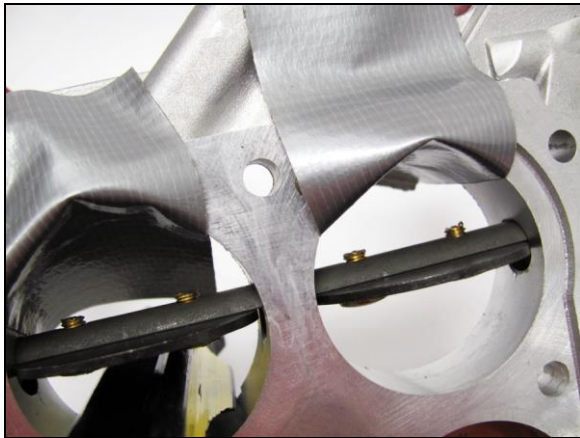

Figure 3

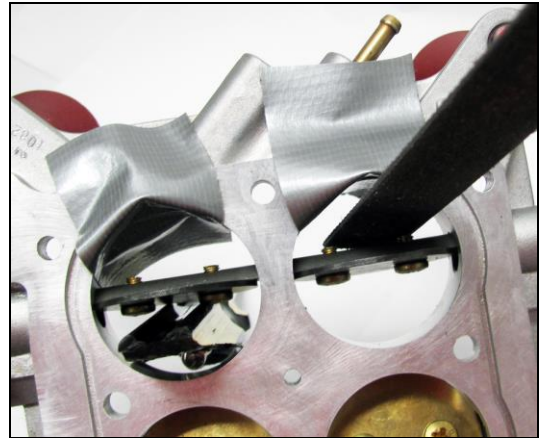

Figure 4

7. With the screws removed, **MARK** each plate, so that they will be placed back into each respective bore. After marking and removing the throttle plates, inspect the throttle shaft where the filing was done and check for any burrs. Address with file, if any burrs are present. It must be **COMPLETELY SMOOTH** (Figure 5). Once this is accomplished, you may then remove the duct tape. Afterwards, blow off the throttle body with compressed air to remove any metal filings and chips.

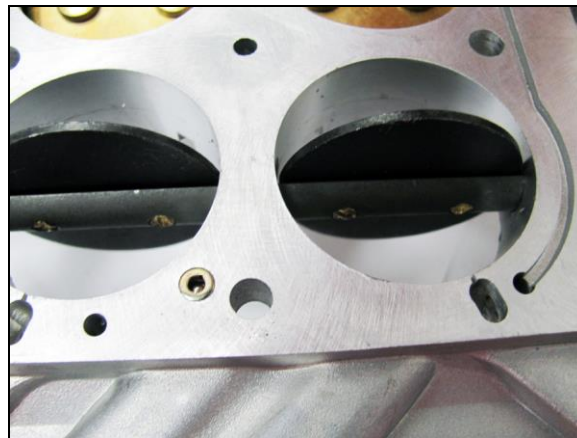

Figure 5

8. Remove the fast idle cam lever and spring assembly (Figure 6). Note how the spring is positioned in the fast idle cam lever. Next, back out the curb idle speed screw six complete turns. Unhook the throttle return spring from the boss on the throttle body. Spray a light coat of WD-40 on the shaft and gently pull the shaft out. Do not force it if you feel any resistance. If so, double check for burrs or metal shavings.
9. Figure 7 shows the new throttle shaft. Make sure that the throttle return spring is positioned in the correct hole on the throttle lever (Figure 7). The holes marked 1 and 2 are used for accelerator pump cam screw. Check the new shaft for any burrs left from the machining process. Clean off and spray a light coat of WD-40 on the shaft and into the throttle shaft hole.
10. Once the shaft is installed, you may now assemble the fast idle cam lever and spring assembly (Figure 8). Also, attach the throttle return spring against its boss on the throttle body. Check for any binding in the shaft by opening and closing the lever.

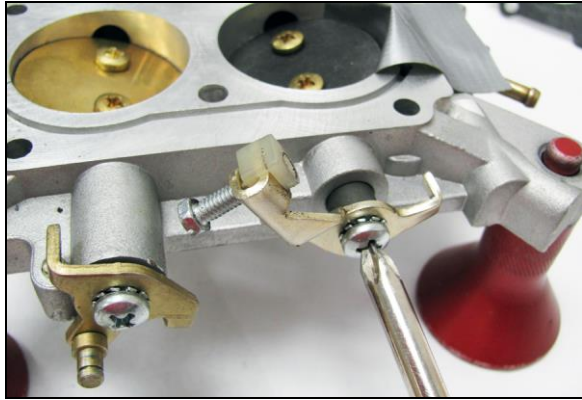

Figure 6

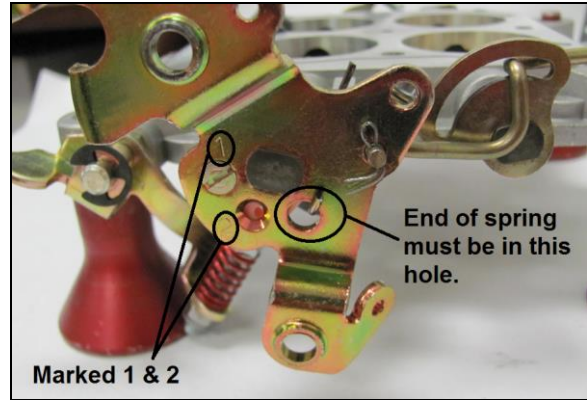

Figure 7

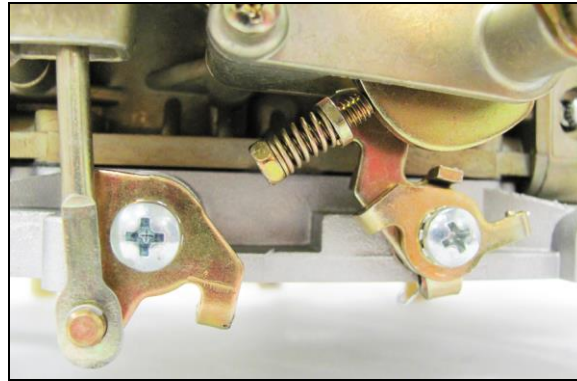

Figure 8

INSTALLATION OF THROTTLE PLATES:

1. To install the throttle plates, first place the throttle body on a carburetor stand or a suitable holding fixture. Take the plate that was removed from the throttle bore that is next to the throttle lever. Notice the part numbers are stamped on each plate. Take the plate and place it into the throttle bore with the letter R facing down and towards the rear of the carburetor. It should rest at roughly a 15° angle in the closed position.
2. With the throttle plate screw holes aligned with the shaft, install the screws. Add 1 drop of Loctite 290 to each screw thread. Snug down both screws, then back out a 1/2 turn. Lightly, open and close the throttle. Do this at least 6 times, so that the plate can seat in the throttle bore. Tighten the screws. Open and close again to check for binding. If there is any, repeat the process.
3. Go to the next throttle bore and do the same. After both plates are installed, open the throttle to the wide-open position and release. Do this as fast as possible at least 10 times. Be absolutely sure that there is NO binding present. Repeat the above procedures, if necessary. Do not go any further, until the problem is solved. Hold the throttle body against a light bulb and check to see that the light passes between both throttle plates and bores are uniform. If not, the plate must be repositioned. This will affect the idle characteristics of the engine.

NOTE: The photo in Figure 12 shows the bottom and side views of the throttle body and throttle plates. Notice that the part numbers stamped on the plates face toward the center of the throttle body. On two barrel carburetors, the numbers will face toward the rear.



Figure 9

4. Making sure that there is no binding in the throttle shaft, you will now restake the throttle plate screws. Use a pair of duck-billed vise grip pliers for this procedure. Using this type of plier, design will prevent damage to the throttle bore (Figure 10).

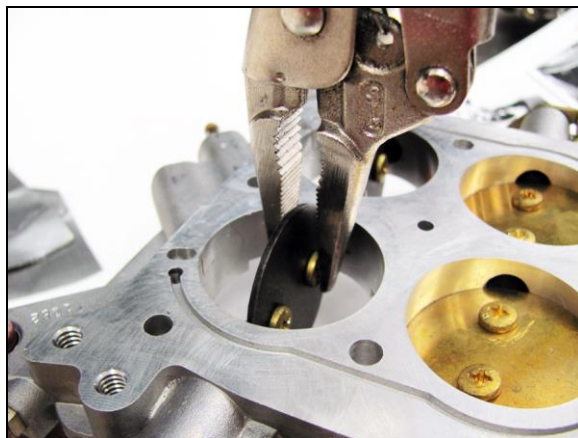

Figure 10

5. Install the main body gasket supplied in this kit. Connect the secondary link (four barrels only) and install the throttle body to the main body. Attach the "C" clip to the secondary diaphragm stem. Remember to readjust the curb idle and replace the carburetor-flange gasket, if the original has been used. Attach the transmission kick-down lever return spring bracket, adjusting screw, and locknut (Figure 11).

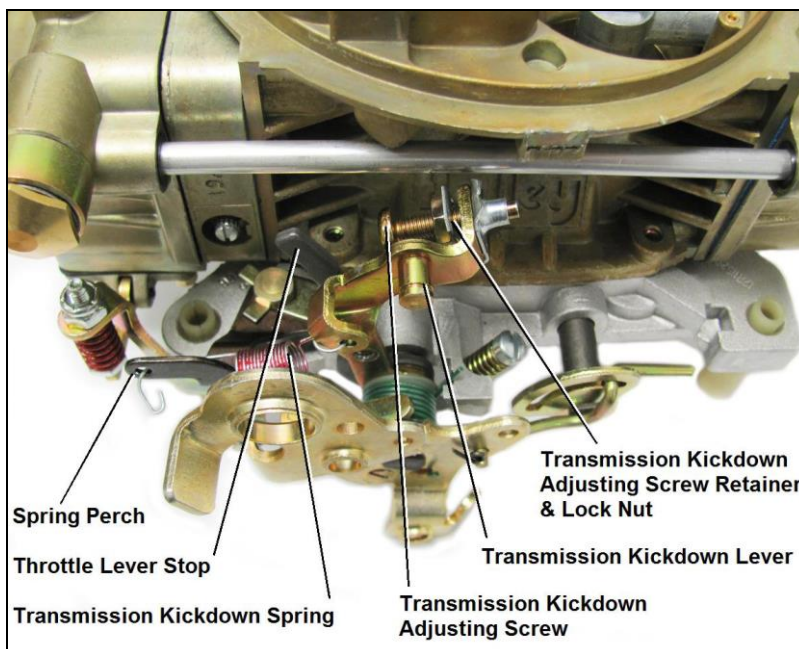

Figure 11

Technical Service: 1-866-464-6553

Phone: 1-270-781-9741

Fax: 1-270-781-9772

For online help, please refer to the Tech Service section of our website: www.holley.com

© 1987 Holley Performance Products, Inc. All rights reserved.

199R9735

Revision Date: 1-22-14